

## Coating Thickness Gages and **Inspection Instruments**

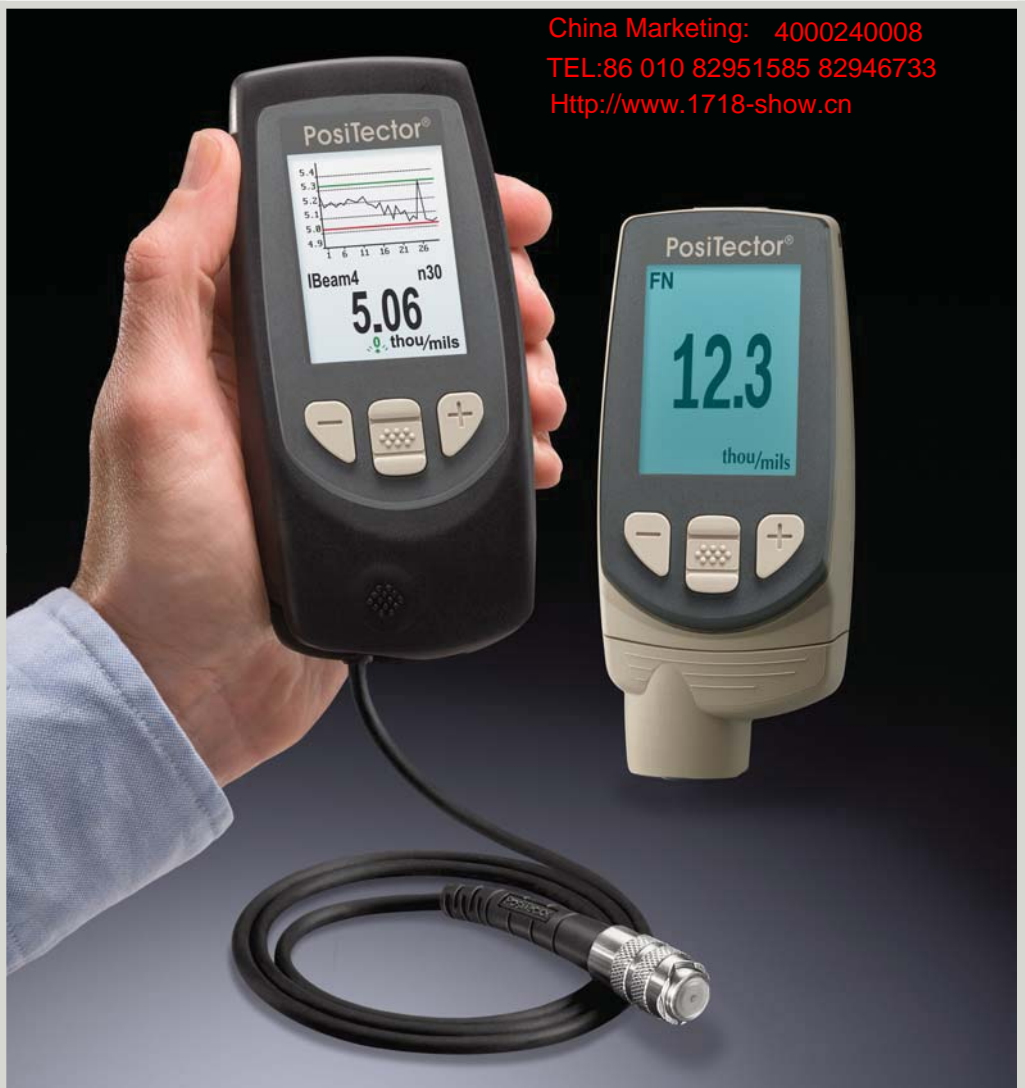

China Marketing: 4000240008  
TEL:86 010 82951585 82946733  
[Http://www.1718-show.cn](http://www.1718-show.cn)



  
Made in U.S.A.

<b>Coating Thickness Gages for Metals</b>		<b>PG.</b>
<b>PosiTector 6000</b>	our most popular electronic gage for measuring coating thickness on all metals. Easy-to-use features for rugged environments.	<b>3 - 6</b>
<b>PosiTest DFT</b>	basic electronic gage for measuring coatings on all metals	<b>7 - 8</b>
<b>PosiTest FM/GM</b>	the industry standard, for measuring non-magnetic coating thickness (paint, plating, galvanizing, etc.) over steel.	<b>9 - 10</b>
<b>PosiPen</b>	small unique magnet for measuring small, hot or hard-to-reach areas on steel.	<b>11 - 12</b>
<b>Coating Thickness Gages for Non-Metals</b>		
<b>PosiTector 200</b>	ultrasonic coating thickness gage measures TOTAL thickness or up to 3 individual layers on wood, concrete and more	<b>13 - 16</b>
<b>Coating Thickness Gages for Uncured Powder</b>		
<b>PosiTector PC</b>	Non-contact Powder Checker coating thickness gage measures uncured powder and predicts cured thickness.	<b>17 - 18</b>
<b>Inspection Instruments</b>		
<b>PosiTest AT</b>	Adhesion Tester measures adhesion of coatings to metal, wood, concrete and other substrates. Available in two models <i>Manual</i> or <i>Automatic</i> .	<b>19 - 22</b>
<b>PosiTector DPM</b>	Measures and records climatic parameters including: air temperature, surface temperature, relative humidity, dew point temperature and the difference between surface and dew point temperatures.	<b>23 - 26</b>
<b>PosiTector UTG</b>	Ultrasonic Thickness Gage is ideal for measuring wall thickness and the effects of corrosion or erosion on tanks, pipes or any structure where access is limited to one side. Thru-Paint model available.	<b>27 - 30</b>
<b>PosiTector SPG</b>	Surface Profile Gage measures and records peak to valley surface profile heights. 2 models to choose from. Standard or Advanced.	<b>31 - 32</b>
<b>PosiTector Inspection Kits</b>		
<b>Inspection Kits</b>	Compact kits contain 1 gage body and 3 probe types to measure and record coating thickness, surface profile and climatic conditions.	<b>33 - 34</b>
<b>Standards</b>		
<b>Thickness Standards</b>	Thickness standards are ideal for checking calibration and operation of coating thickness gages and are an important component in fulfilling both ISO and in-house quality control requirements.	<b>35 - 36</b>

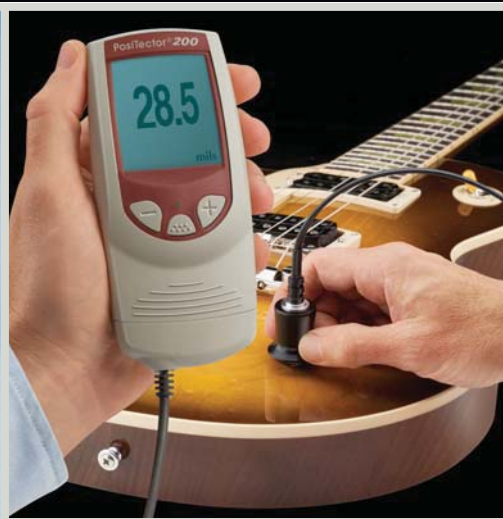
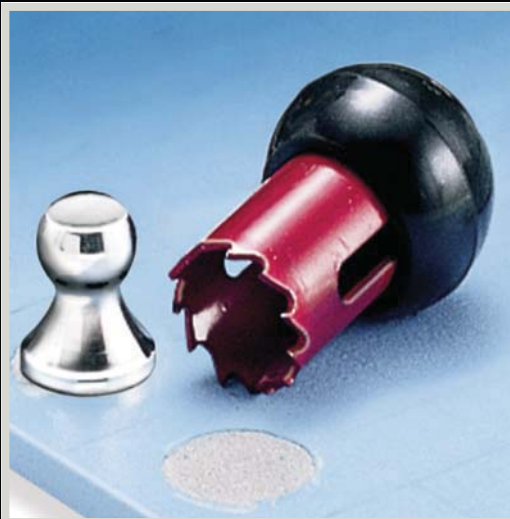



# PosiTector® 6000 Series

Coating Thickness Gages for  
**ALL** Metal Substrates



**DeFelsko®**

The Measure of Quality

# PosiTector® 6000 Series

## All Gages Feature...

### Simple

- Ready to measure—no calibration adjustment required for most applications
- Enhanced one-handed menu navigation
- Flashing display—ideal in a noisy environment
- RESET feature instantly restores factory settings

### Durable

- Solvent, acid, oil, water and dust resistant—weatherproof
- Wear-resistant probe tip
- Shock-absorbing, protective rubber holster with belt clip
- Two year warranty on gage body AND probe

### Accurate

- Certificate of Calibration showing traceability to NIST included
- Built-in temperature compensation ensures measurement accuracy
- Hi-RES mode increases displayed resolution for use on applications that require greater precision
- Conforms to national and international standards including ISO and ASTM

### Versatile

- PosiTector body universally accepts all PosiTector 6000, SPG and DPM probes easily converting from a coating thickness gage to a surface profile gage or dew point meter
- Multiple Calibration adjustment options including 1 point, 2 point, known thickness, average zero
- Selectable display languages
- Hi Contrast backlit display for bright or dark environments
- Flip display enables right-side-up viewing
- Extended cables available (up to 75 m/250 ft) for remote measuring
- Uses alkaline or rechargeable batteries (built-in charger)

### Powerful

- Continually displays/updates average, standard deviation, min/max thickness and number of readings while measuring
- HiLo alarm audibly and visibly alerts when measurements exceed user-specified limits
- FAST mode—faster measurement speed for quick inspection
- USB port for fast, simple connection to a PC and to supply continuous power. USB cable included
- USB mass storage—stored readings and graphs can be accessed using universal PC/Mac web browsers or file explorers. No software required
- Every stored measurement is date and time stamped
- Software updates via web keep your gage current
- Connects to PosiTector.net (see far right panel)

## Probes available for a variety of applications



For measuring paint, powder, etc. on all metals...



...and for measuring galvanizing, plating, anodizing and more.

## Gage Selection...

### Select Substrate

- F** — for ferrous metals (steel and cast iron)
- N** — for non-ferrous metals (aluminum, copper, etc.)
- FN** — for all metal substrates—Gage automatically recognizes the substrate and takes a measurement

### Select Standard or Advanced Features

#### Standard Models

Includes ALL features as shown on left plus...

- Monochrome display
- Storage of 250 readings—stored readings can be viewed or downloaded

#### Advanced Models

Includes ALL features as shown on left plus...

- Hi Contrast reversible color LCD
- Storage of 100,000 readings in up to 1,000 batches and sub-batches
- Onscreen help, real time graphing, picture prompting and batch notes
- **NEW!** WiFi technology wirelessly synchronizes with PosiTector.net, downloads software updates, and connects to mobile devices for expanded functionality
- Data transfer via USB to a PC or via  **Bluetooth**® Wireless Technology to a PC or printer
- Scan mode—take continuous readings without lifting the probe
- Multiple stored calibration adjustments for measuring on a variety of substrate conditions
- SSPC PA2 feature determines if film thickness over a large area conforms to user-specified min/max levels
- PSPC 90/10 feature determines if a coating system complies with an IMO performance standard for protective coatings

### Select from a variety of measurement ranges and probe styles

(see back page ordering guide)

**Heavy-duty, gold-plated locking connector for industrial environments**



**Removable Built-in Probe** can be detached and replaced with any one of our wide variety of probes including separate probes and microprobes



FKS

90°

0°

45°

Regular



## Rugged Features...

**WEATHERPROOF**

Sealed USB Port for communicating with a PC or Mac

Water and dust resistant—weatherproof

Hi resolution color LCD

Scratch/solvent/impact resistant lens

Multi-function navigation button

Solvent, acid, oil resistant, hi-grade, industrial strength housing

**Advanced Model shown in Memory mode**

Quality high-flex cable and strain relief

Stainless steel probe with knurled finger grip

Strong wear-resistant ruby-tipped probe

All Regular Separate Probes are suitable for underwater use



Standard Model shown in Statistics mode with shock-absorbing, protective rubber holster



High-Range Probes for thick coatings, e.g. fireproofing, tank linings, etc.



Flip Display enables right-side-up viewing



Microprobe series for small parts and hard-to-reach areas

PosiTector.net

by DeFelsko

Home

My Gages

What's New











My Account

where your gage meets the cloud™



**A free web-based application offering secure centralized management of thickness readings**

- Synchronize measurement data when connected via USB or WiFi (Advanced models only)—measurements are uploaded to a secure server; images and batch notes are downloaded to your gage
- Manipulate uploaded data using a standard internet web browser from any location in the world—job site or head office
- Generate reports and graphs with annotations and user selected images
- Share measurement data with authorized users via a secure login from any computer and most web enabled devices
- Export data to XML and text files
- Visit [www.defelsko.com/PosiTectorNET](http://www.defelsko.com/PosiTectorNET) for a demonstration

<b>PosiTector® 6000 Series</b>  <b>ORDERING GUIDE</b>		Our most popular Removable Built-in and Regular Separate probe models			90° Regular probe for tight spots	Ideal for anodized aluminum	Microprobes – Our smallest probes for small parts or hard-to-reach areas			Removable Built-in and Separate probes for thick protective coatings; epoxy, rubber, intumescent fire proofing and more		
												
<b>Non-Magnetic Coatings over FERROUS Metals (Steel and Iron)</b>	Standard	F1	FS1	FRS1		FOS1	F45S1	F90S1	FT1	FTS1	FKS1	
	Advanced	F3	FS3	FRS3		FOS3	F45S3	F90S3	FT3	FTS3	FKS3	
<b>Non-Conductive Coatings on NON-FERROUS Metals (Aluminum, Copper, etc.)</b>	Standard	N1	NS1	NRS1	NAS1	NOS1	N45S1	N90S1			NKS1	
	Advanced	N3	NS3	NRS3	NAS3	NOS3	N45S3	N90S3			NKS3	
<b>Combination ALL METALS</b>	Standard	FN1	FNS1	FNRS1						FNTS1		
	Advanced	FN3	FNS3	FNRS3						FNTS3		
<b>Range</b>		0 – 60 mils 0 – 1500 µm			Ferrous: 0 – 45 mils and 0 – 1150 µm Non-Ferrous: 0 – 25 mils and 0 – 625 µm			0 – 250 mils 0 – 6 mm		0 – 500 mils 0 – 13 mm		
<b>Accuracy*</b>		±(0.05 mils + 1%) 0 – 2 mils ±(0.1 mils + 1%) > 2 mils  ±(1 µm + 1%) 0 – 50 µm ±(2 µm + 1%) > 50 µm			±(0.02 mils + 1%) 0 – 4 mils ±(0.1 mils + 3%) > 4 mils  ±(0.5 µm + 1%) 0 – 100 µm ±(2 µm + 3%) > 100 µm			±(0.5 mil + 1%) 0 – 100 mils ±(0.5 mil + 3%) > 100 mils  ±(0.01 mm + 1%) 0 – 2.5 mm ±(0.01 mm + 3%) > 2.5 mm		±(1 mil + 3%) 0 – 500 mils  ±(0.02 mm + 3%) 0 – 13 mm		
<b>Matching DeFelsko Calibration Standards</b>		STDS1 STDA1			STDS2 STDA2			STDP1		STDP5		

\*Accuracies are stated as a fixed value plus a percentage of the gage's actual reading. EXTENDED CABLES available for underwater or remote measuring. Specify length when ordering.

## Probe Details

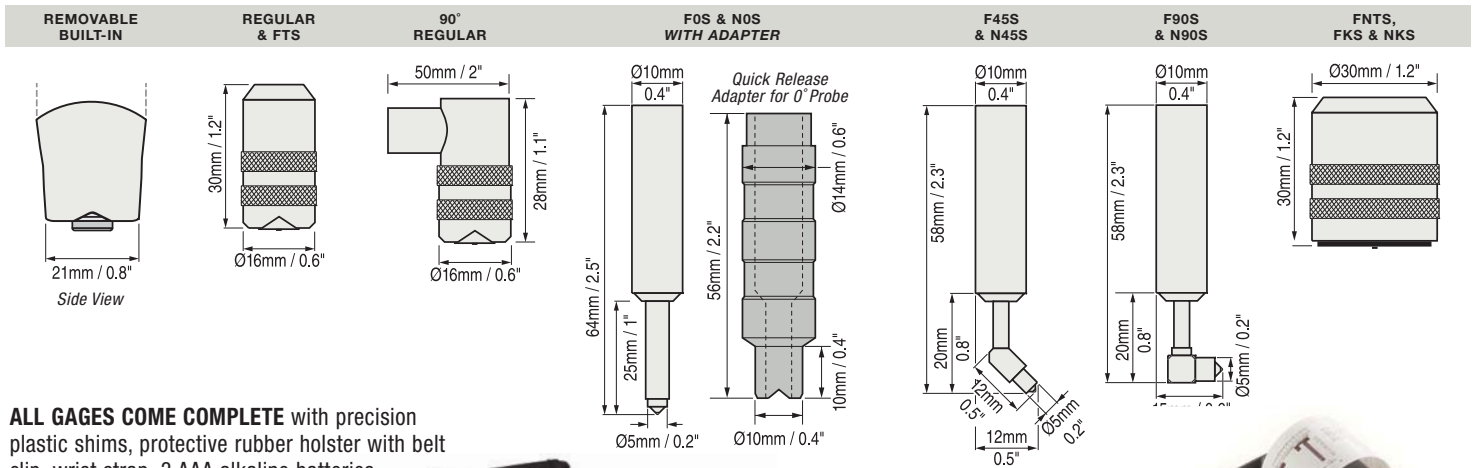

**ALL GAGES COME COMPLETE** with precision plastic shims, protective rubber holster with belt clip, wrist strap, 3 AAA alkaline batteries, instructions, nylon carrying case with shoulder strap, protective lens shield, Long Form Certificate of Calibration traceable to NIST, USB cable, two (2) year warranty.

**SIZE:** 137 x 61 x 28 mm (5.4" x 2.4" x 1.1")

**WEIGHT:** 140 g (4.9 oz.) without batteries

Conforms to ISO 2178/2360/2808, PrEN ISO 19840, ASTM B499/D1186/D1400/D7091/E376/G12, BS3900-C5, SSPC-PA2 and others



## Options

**Bluetooth Printer** receives data from Advanced models

**AC Power Kit** for continuous operation or battery charging—works in any country

**Coating Thickness Standards** to fulfill both ISO and in-house quality control requirements

**Rechargeable Batteries**—a set of eneloop NiMH AAA batteries

**Protective Lens Shields** protect the display from overspray



**DeFelsko®**  
The Measure of Quality

China Marketing: 4000240008  
TEL:86 010 82951585 82946733  
Http://www.1718-show.cn

  
Made in U.S.A.



# PosiTest<sup>®</sup> DFT

## Coating Thickness Gage

### *Ideal for...*

- Powder Coaters
- Paint Applicators
- Coating Inspectors
- Painting Contractors
- Automotive Refinishers

### *2 Models...*

**Ferrous** for STEEL

**Combo** for ALL METALS



simply  
measures

**DeFelsko<sup>®</sup>**  
*The Measure of Quality*

# PosiTest<sup>®</sup> DFT

## Coating Thickness Gage

Actual Size



### Two Models

- **PosiTest DFT Ferrous**  
measures non-magnetic coatings on steel.
- **PosiTest DFT Combo**  
measures both non-magnetic coatings on steel AND non-conductive coatings on aluminum, brass, etc. **Automatically** recognizes the substrate and takes a measurement.

### Features

- Fast, repeatable measurements
- No calibration required for most applications
- ZERO feature for rough or curved surfaces
- Handy RESET feature when no zero reference is available
- Strong, wear-resistant, ruby-tipped probe
- Unique FLIP Display enables right-side-up viewing in any position
- Audible and visible measurement indication
- V-groove in probe for positioning on cylindrical parts
- Mils/Microns switchable
- Basic instructions on the back of each gage
- Built-in wrist strap for added convenience and safety
- 2 Year Warranty

### Specifications

Measurement Range	0 – 40 mils	0 – 1000 µm
Accuracy	±(0.1 mils + 3%)	±(2µm + 3%)
Size	4 x 1.5 x 0.9 in.	100 x 38 x 23 mm
Weight	2.5 oz.	70 g



**Unique FLIP Display enables right-side-up viewing in any position**



**Gage Comes Complete** with built-in probe, wrist strap, plastic shims, hard shell storage case, AAA battery, instructions and two (2) year warranty.

**Conforms to:** ISO 2178/2360/2808, prEN ISO 19840, ASTM B244/B499/B659/D1186/D1400/D7091/E376/G12, BS3900-C5, SSPC-PA2 and others. *Certificate of Calibration traceable to NIST available.*

© DeFelsko Corporation USA 2008. All Rights Reserved. Technical Data subject to change without notice. U.S. Patent # Re.35,703 • Printed in U.S.A. PDFT.v.LW/W0804



# PosiTest<sup>®</sup> *Accurate & Dependable*

*For the non-destructive measurement of non-magnetic coatings (paint, enamel, galvanizing, metalizing, plating, etc.) on STEEL*



Easily measures  
small parts of  
almost any shape



Stable design with additional  
tail-end support. No annoying  
rocking during measurement.

**DeFelsko<sup>®</sup>**  
*The Measure of Quality*

# PosiTest<sup>®</sup> *Accurate & Dependable*

*For the non-destructive measurement of non-magnetic coatings (paint, enamel, galvanizing, metalizing, plating, etc.) on STEEL*

## ACCURATE

- Certificate of Calibration showing traceability to N.I.S.T. included with every gage
- Matching Calibration Standards and Procedures available for every model
- Highly wear resistant Carbide Probe for longest life and continuous accuracy
- Remove center of dial cover for easy calibration adjustment
- Conforms to national and international standards

## DURABLE

- Extra rugged housing, not affected by mechanical shock, water, acid or solvents
- Unique overall design, fully supported, positive positioning, no pivoting tendencies during measurement
- Can be used fully supported or with only the front probe area contacting the surface
- Functions on a permanent rare-earth cobalt magnet
- No batteries/electronics
- 2 year warranty

## EASY TO USE

- Positive visual and audible indicators to designate when thickness reading is established
- "V" grooves in probe housing and Gage base allow correct positioning on cylindrical objects
- Compact, lightweight, precisely balanced, independent of gravity – can be used in any position
- GO/NO-GO button can be pre-set for rapid measurement
- Probe contact and dial rotation all in a one-finger operation
- Furnished with wrist strap and instructions in a high quality leather case with belt loops for your convenience



Carbide measuring probe for long life.

**FOR: Hot dip galvanizing, hard chrome metalizing, paint, enamel coatings on steel**

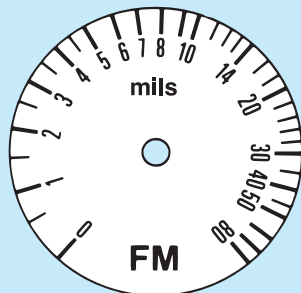

Scale FM 0–80 mils  
Tolerance: ±0.2 mils up to 4 mils  
±5% of the reading over 4 mils

Scale F 0–2000 microns  
Tolerance: ±5 microns up to 100 microns  
±5% of the reading over 100 microns

**FOR: Electroplating, thin paint films, phosphating on steel**

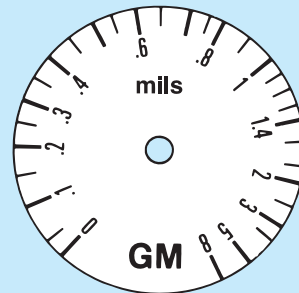

Scale GM 0–8 mils  
Tolerance: ±0.04 mils up to 0.8 mils  
±5% of the reading over 0.8 mils

Scale G 0–200 microns  
Tolerance: ±1 micron up to 20 microns  
±5% of the reading over 20 microns

**DeFelsko<sup>®</sup>**  
*The Measure of Quality*

China Marketing:

TEL:86 010 82951585 82946733 4000240008

Http://www.1718-show.cn

  
Made in U.S.A.



# PosiPen®

## Coating Thickness Gage



Measures non-magnetic coatings  
such as paint, enamel, plating,  
hot-dip galvanizing on steel.

Ideal for measuring on small,  
hot or hard-to-reach surfaces.



# PosiPen<sup>®</sup> Coating Thickness Gage

*Measures non-magnetic coatings such as paint, enamel, plating, hot-dip galvanizing on steel.*

PosiPen has a very small, unique magnet which can be placed with pin-point accuracy on extremely small parts, and on peaks and valleys.

## Used for:

- Small, hot or hard-to-reach surfaces
- Spot Checks - conveniently fits in a shirt pocket
- Hot Sprayed Coatings

## Ideal for:

- Refineries, petrochemical plants
- Platers - electroplating, chrome, zinc, galvanizing
- Powder coaters

## Simple

- Easy-to-Use
- Lightweight - easy to carry, just like a ball point pen

## Durable

- No batteries/Electronics
- Rugged - not affected by mechanical shock, acid, oil, water and dust

## Accurate

- No user adjustment required
- Certificate of Calibration traceable to NIST included
- Highly wear resistant probe tip for long life and continuous accuracy



	English	Metric
<b>Range</b>	0.25 to 20 mils	5 to 500 microns
<b>Tolerance</b>	+/-10% and 0.1 mil	+/-10% and 2.5 microns
<b>Temperature</b>	-150° F to + 450° F	-100° C to + 230° C

Conforms to National and International Standards including ASTM D7091/B499, ISO 2808 and others

## Triple Indicator: compensates for gravity

1. Use the **red/silver joining line** when the Gage is horizontal (walls).
2. Use the **green line** when the Gage is pointing straight down (green/ground).
3. Use the **blue line** when the Gage is pointing straight up (blue/sky).

**Gage comes complete** with leather pouch, instructions, Certificate of Calibration traceable to NIST, two (2) year warranty.

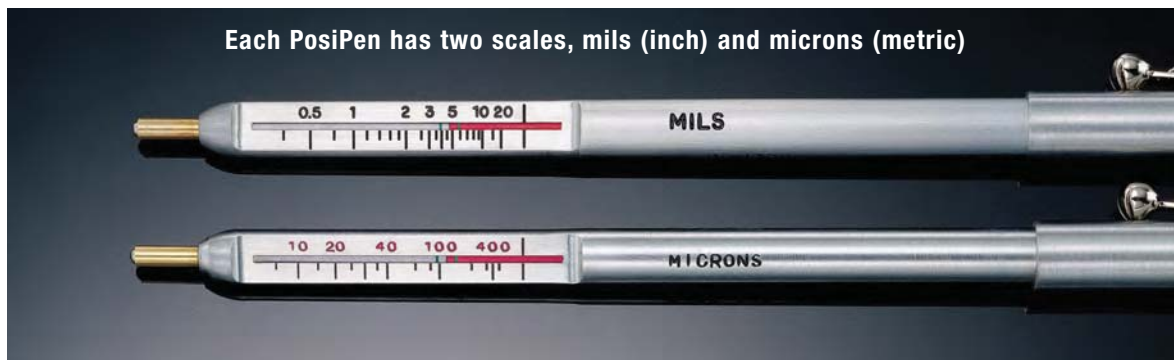

## Easy to Use:

Place the tip of the PosiPen on the coated surface and allow the magnet to contact. Pull the PosiPen straight from the object to be measured while keeping close watch on the appropriate indicator. Note the reading when the magnet releases.



# PosiTector® 200 Series

Coating Thickness  
Gages for Measuring  
on Wood, Concrete,  
Plastic and more...



Standard Model



Advanced  
Model  
measures  
up to 3  
layers with  
graphics

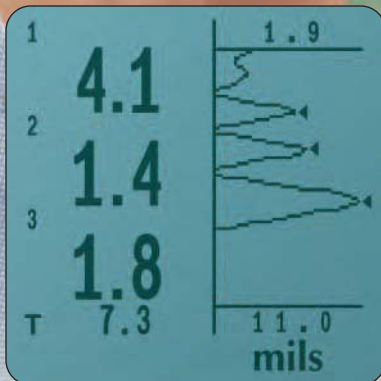

**DeFelsko®**

The Measure of Quality

# PosiTector® 200 Series

Non-destructively measures a wide variety of applications using proven ultrasound technology. Measures the thickness of coatings over concrete, wood, composite materials and more.

## All Gages Feature...

### Simple

- Ready to measure – no adjustment required to measure most coatings
- One-handed menu navigation
- Bi-color indicator light – ideal in a noisy environment
- RESET feature instantly restores factory settings

### Durable

- Solvent, acid, oil, water and dust resistant – meets or exceeds IP5X
- Scratch/Solvent resistant display suitable for harsh environments
- Shock-absorbing, protective rubber holster with belt clip
- Two year warranty on both gage body and probe

### Accurate

- Responsive transducers provide fast, accurate readings (up to 40 readings/minute)
- Proven non-destructive ultrasonic technique conforms to ASTM D6132 and ISO 2808
- Certificate of Calibration showing traceability to NIST included

### Versatile

- Continually displays/updates average, standard deviation, and number of readings while measuring
- Internal memory stores up to 10,000 readings in up to 1000 batches
- Built-in clock to date and time stamp each stored measurement
- USB, IR and serial output options for simple communication with printers and PCs
- Backlit display for dim or dark environments
- Mils/Microns switchable
- Selectable display languages

## Select Standard or Advanced

**Standard models** measure the total thickness of a coating system.

**Advanced models** measure total thickness of a coating system or up to 3 individual layer thicknesses in a multi-layer system. Also features graphic readout for detailed analysis of the coating system.

## Advanced Model Graphic Display



Advanced models toggle between graphic readout and statistical data displays.



Standard model measuring total coating thickness on wood

Easy-to-read graphic format provides clear, detailed analysis of coatings

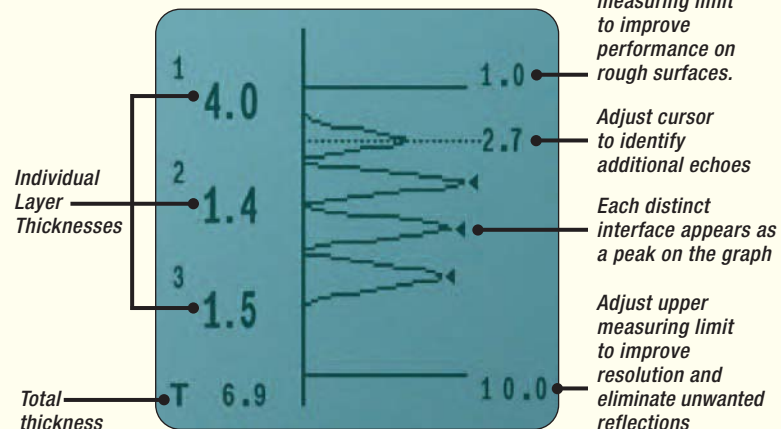



## Tough **NEW** Features

- USB/IR Ports for downloading to a PC or printer

- Solvent, acid, oil, water and dust resistant—meets or exceeds IP5X

- Scratch and solvent resistant lens

**Standard model shown in Memory Mode**

- Thick impact-resistant display

- Bi-color indicator light

- Hi-grade, industrial strength housing

- Shock-absorbing, protective rubber holster

- Quality high-flex cable and strain relief

- Comfortable ergonomic finger grip reduces operator fatigue

- Plastic-tipped probe will not scratch surface



## Easily measure single or multiple layer coating thickness on a variety of substrates.



Measure paint, varnish, lacquer, etc. on wood products including cabinetry, furniture, flooring, windows and more.



Measure thick protective coatings on concrete flooring, pipes, containment structures and more.



*Advanced model*

Measure protective finish topcoats over epoxy resin – commonly found in automotive, marine and aviation applications.

## Options

### PosiSoft® for Windows® analysis software

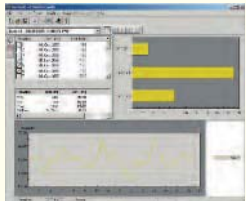

- Downloads stored readings to a PC
- Allows entry of notes and annotations
- Prints and displays basic charts and histograms
- Exports to a document or spreadsheet
- Includes USB cable
- Free updates

**IR Printer** receives data from all models via wireless infrared.



**Coating Thickness Standards** fulfill both ISO and in-house quality control requirements.

**AC Power Cable** for continuous operation.

Visit [www.defelsko.com/applications.htm](http://www.defelsko.com/applications.htm) to view **Coating Inspection Application Notes.**

## SPECIFICATIONS

PosiTector <sup>®</sup> 200 Model	B/Std	B/Adv	C/Std	C/Adv
Measures Total Thickness	✓	✓	✓	✓
Measures Individual Layers		✓		✓
Graphic Display		✓		✓
Typical Applications	Polymer coatings on wood, plastic, etc.		Thicker coatings on concrete, fiberglass, etc.	
Range*	13 – 1000 microns 0.5 – 40 mils		50 – 3800 microns 2 – 150 mils	
Accuracy	±(2 microns + 3% of reading) ±(0.1 mils + 3% of reading)			
Minimum Individual Layer Thickness**	_____	13 microns 0.5 mils	_____	50 microns 2 mils
Thickness Standard	DeFelsko STDA3		DeFelsko STDP6	

\*Range limits apply to polymer coatings only. \*\*For multiple layer applications only. Dependent on material being measured.

### Probe Details

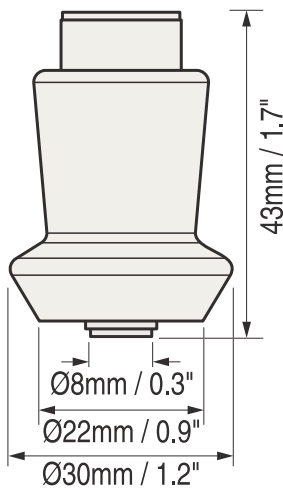

**ALL GAGES COME COMPLETE** with probe, precision plastic shims, protective rubber holster with belt clip, couplant, 3 AAA batteries, instructions, nylon carrying case with shoulder strap, Certificate of Calibration traceable to NIST, two (2) year warranty.

**SIZE:** 146 x 64 x 31 mm  
(5.75" x 2.5" x 1.2")

**WEIGHT:** 165 g (5.8 oz.)  
without batteries

Conforms to ASTM D6132  
and ISO 2808



**DeFelsko<sup>®</sup>**  
The Measure of Quality

China Marketing:  
TEL: 86 010 82951585 82946733 4000240008  
Http://www.1718-show.cn

  
Made in U.S.A.



# PosiTector® **PC** *Powder Checker*®

Non-contact Uncured  
Powder Thickness Gage



Affordably measures uncured powder coatings using non-contact ultrasonic technology to automatically calculate and display a predicted cured thickness.



**DeFelsko®**  
*The Measure of Quality*



# PosiTector® **PC** Powder Checker®

Non-contact coating thickness gage measures uncured powder and predicts cured thickness.

## Simple

- Hand-held, battery operated
- No calibration adjustment required for most powders
- Thickness results appear on both base unit and probe
- Bi-color indicator light—ideal in a noisy environment

## Durable

- Solvent, acid, oil, water and dust resistant—ideal for powder coating environments
- Shock-absorbing, protective rubber holster with belt loop and magnetic mount for easy storage
- Replaceable screen protects the probe
- Two year warranty on both base unit and probe

## Accurate

- Conforms to ASTM D7378
- Advanced new technology allows measurement on small tubes, odd shapes and moving parts
- Easy calibration adjustment options improve accuracy on unusual powders or substrates

## Versatile

- Wireless probe communicates with base unit up to 10m away (30 feet). No cable to risk disturbing applied powder
- Selectable display languages
- Backlit displays for dim or dark environments
- Long battery life—uses standard alkaline batteries

## Powerful

- Continually displays/updates basic statistics including min/max and average
- USB Mass Storage of 1,000 readings in up to 100 batches
- Built-in IR port for printing stored results to an optional wireless printer
- USB port for fast and easy connection to a PC and to supply continuous power
- No download software required—gage generates formatted reports with measurement summaries and charts
- Live measurement results can be sent to a data collector or spray booth controller



Specifications	
Range	20–110 $\mu\text{m}$ (0.8–4.3 mils)
Resolution	1 $\mu\text{m}$ (0.05 mils)
Accuracy	$\pm 5 \mu\text{m}$ ( $\pm 0.2$ mil)
Measurement Time	2–5 seconds
Measurement Distance to Powder	18 mm (0.75 inch)
Measurement Area	2 mm (0.08 inch)

### BASE UNIT

Size: 146 x 64 x 31 mm (5.75" x 2.5" x 1.2")  
Weight: 165 g (5.8 oz.) without batteries

### PROBE

Size: 222 x  $\varnothing 50$  mm (8.75" x  $\varnothing 2.0$ ")  
Weight: 272 g (9.6 oz.) without batteries



### GAGE COMES COMPLETE

with base unit and probe, protective rubber holster with belt loop and magnetic mount, probe fixture, 3AAA batteries (base unit), 3 AA batteries (probe), instructions, instructional video, replacement probe screen, USB cable, carabiner and wrist strap, durable carrying case, two (2) year warranty.



**DeFelsko®**  
The Measure of Quality

China Marketing:  
TEL:86 010 82951585 82946733 4000240008  
Http://www.1718-show.cn

# PosiTest<sup>®</sup>

## *Pull-Off Adhesion Tester*

Measures adhesion of coatings to metal, wood, concrete and other substrates – revolutionary self-alignment feature and pull rate indicator.



**IP65**



**Available  
in 2 models...**

**Manual or Automatic**

**DeFelsko<sup>®</sup>**  
The Measure of Quality



Measures the force required to pull a specified test diameter of coating away from its substrate using hydraulic pressure.

## AT-A Automatic

Electronically controlled hydraulic pump automatically applies smooth and continuous pressure at a user-specified rate-of-pull

USB port for downloading

AC Adapter port charges batteries or powers instrument

Environmentally sealed, one-piece metal enclosure

Cutting tool for isolating test area

Reach difficult areas with 5 ft (1.5 m) quality flex hose

Self-aligning, quick-coupling secures dollies to actuator

Single-use, self-aligning dollies ensure even, consistent pull-offs

## Both Models Feature...

### Simple

- Portable – requires no external power source – ideal for lab and field use
- Pull Rate Indicator allows operator to easily monitor and adjust the rate of pull in accordance with international test methods
- Easily select dolly sizes, change measurement units or store readings, with the touch of a button
- Conversion charts not required – tester automatically calculates pressure based on dolly size
- Inexpensive, single-use dollies eliminate cleaning for re-use and can be kept as a permanent record
- Each kit comes with everything needed for testing

### Durable

- Environmentally sealed enclosure – weatherproof, dustproof and shockproof – meets or exceeds IP65
- Can be used in any position
- Rugged carrying case
- Two year warranty

### Accurate

- Every PosiTest Adhesion Tester pressure system is calibrated and certified to  $\pm 1\%$  accuracy using NIST traceable load cell
- Self-aligning aluminum dolly enables accurate measurements on smooth or uneven surfaces
- Hi-grade, industrial pressure sensor ensures continued accuracy
- Conforms to national and international standards including ASTM D4541/D7234, ISO 4624/16276-1, AS/NZS 1580.408.5 and others

### Versatile

- Internal Memory stores maximum pull-off pressure, rate of pull, test duration and dolly size for up to 200 pulls
- Optional PosiSoft® software available for downloading
- 10, 14, 20 or 50 mm dollies maximize capability and measurement resolution across a wide range of bond strengths
- LCD displays pressure value in psi or MPa

### Self-Alignment Feature

The PosiTest Adhesion Tester compensates for misalignment. The self-aligning, quick-coupling actuator and spherical articulating dolly head enable uniform distribution of the pulling force over the surface being tested, preventing a one-sided pull-off.

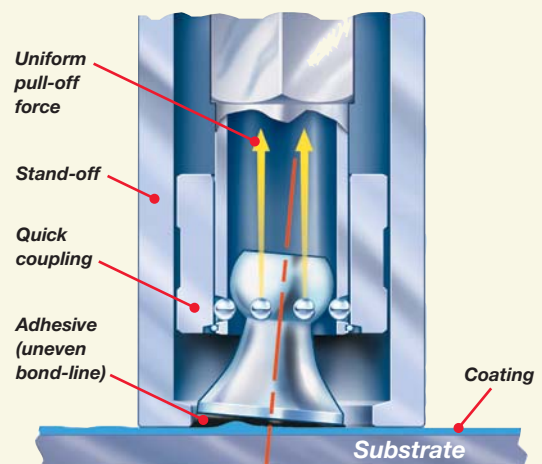



# PosiTest® **AT-M Manual** Adhesion Tester



**AT-M Manual**

- Heavy-duty manual hydraulic pump designed to apply smooth and continuous pressure with a single stroke
- Pull Rate Indicator to manually monitor and adjust the rate of pull

# PosiTest® **AT-A Automatic** Adhesion Tester

- Electronically controlled hydraulic pump automatically applies smooth and continuous pull-off pressure at a user-specified rate
- Test with the simple push of a button. No twisting, pumping or cranking. No valves to close, needles to reset, or scales to adjust
- User selectable pull rates ensure compliance with international test methods for a variety of industries including metal, wood and concrete
- Built-in rechargeable batteries perform over 200 tests per charge. Continue testing with AC power while batteries recharge. Supplied with universal AC Adapter



**AT-A Automatic**  
Rugged, portable instrument ideal for lab and field use

The image shows a detailed view of the LCD screen of the PosiTest AT-A Automatic Adhesion Tester. The screen displays a large digital reading of '1457' in blue digits. Above the reading, there are two horizontal bars: a blue bar for 'MPa/s' and a yellow bar for 'psi/s'. The blue bar has markings at 0, 0.25, 0.5, 0.75, 1.0, and 1.25. The yellow bar has markings at 0, 50, 100, 150, and 200. The unit 'psi' is displayed to the right of the reading. Below the reading, the text 'PosiTest AT-A Automatic Adhesion Tester' is visible. The screen is surrounded by a grey border with several control buttons and indicators. Red lines with callouts point to various features:

- Low battery indicator**: A small icon in the top left corner of the screen.
- Memory mode icon indicates readings are in memory**: A small icon in the top right corner of the screen.
- Select measurement units**: A button labeled 'psi/MPa'.
- Select dolly size**: A button with a dolly icon.
- Select Pull Rate in accordance with international test methods**: A button with a bar graph icon.
- One-touch save feature stores and reviews readings in memory**: A button with a floppy disk icon.
- On/Start**: A green button with a vertical bar icon.
- Off/Stop**: A red button with a square icon.
- Pull Rate indicator to easily set and monitor the specified rate of pull**: A yellow bar at the top of the screen.
- Large, easy-to-read LCD displays pressure during measurement and holds maximum value**: The main digital display area.



PosiTest AT-M  
Manual model

**Kit Weight** (with case): 13 lbs / 6 kg

**Carrying Case Dimensions:** L – 17 in / 43 cm x W – 13 in / 33 cm x H – 6 in / 15 cm

## Specifications

<b>Dolly Size (mm)*</b>	20 mm
<b>Resolution</b>	1 psi (0.01 MPa)
<b>Accuracy</b>	± 1% Full Scale
<b>Adhesion Strength**</b>	100 – 3000 psi (0.7 – 20 MPa)

\*Additional dolly sizes available to meet specific measuring needs – contact supplier for details. \*\*Varies with dolly size

**Both Kits include:** Adhesion tester with digital display, built-in rechargeable NiMH batteries with charger, 20 mm aluminum test dollies (20), abrasive pad, cutting tool, adhesive with mixing sticks and palettes, cotton swabs, instruction booklet and video, Certificate of Calibration traceable to NIST, two-year warranty, and sturdy, lightweight carrying case

## Options



### 50 mm Accessory Kit

- Ideal for lower bond strength finishes such as coatings on wood, concrete and plastic
- Larger surface area of dolly provides improved low range precision and repeatability
- Range 50 – 500 psi (0.4 – 3.5 MPa)
- Includes 50 mm stand-off, 50 mm hole saw and 50 mm aluminum test dollies (12)

### Drilling Template for 20 mm and 50 mm Dollies

- Drilling template and drill bits to isolate test area, ideal for thicker coatings on concrete

### Adhesive Kit

- Additional adhesive, mixing sticks, palettes and cotton swabs

### PosiSoft® for Windows® analysis software

- Displays pressure, rate, test duration and dolly size for up to 200 pulls
- Calculates max, min, mean and standard deviation
- Prints and displays basic charts and histograms
- Real time graphing of individual pulls for a more detailed analysis of applied pressure over time (AT Manual only)
- Allows entry of notes and annotations
- Exports to a document or spreadsheet
- Multi-language support including English, German, Italian, Spanish and French
- Includes USB cable
- Free updates



### Dollies

- Additional supplies of 10, 14, 20 and 50 mm dollies



**DeFelsko®**  
The Measure of Quality

China Marketing:

TEL:86 010 82951585 82946733 4000240008

Http://www.1718-show.cn





# PosiTector® **DPM** Dew Point Meter

Ideal for Use  
Outdoors & Indoors



PosiTector®

B2 n3  
%RH 73.5 ↓  
Ta 26.5  
Ts 29.9 ↑  
Td 21.4  
Ts-Td 8.5 ↑  
 °C

Measures and records climatic conditions including:

Relative humidity, air temperature, surface temperature, dew point temperature and difference between surface and dew point temperatures. Ideal for surface preparation as required by ISO 8502-4.



Standard model shown with separate probe

Advanced model shown with built-in probe



Available on the App Store

**DeFelsko®**  
The Measure of Quality



# PosiTector® Dew Point Meter

## A New Level of Confidence for painting contractors & inspectors.

### Simple

- Enhanced one-handed menu navigation
- No need to consult complex tables or use a slide rule calculator
- Audio and visual alarm – indicates when climate conditions are unsuitable for painting
- All readings are constantly updated and displayed simultaneously
- RESET feature instantly restores factory settings

### Durable

- Rugged, outdoor/indoor instrument
- Solvent, acid, oil, water and dust resistant – weatherproof
- Shock-absorbing, protective rubber holster with belt clip
- Two year warranty on body and probe

### Accurate

- Fast response precision sensors provide accurate, repeatable readings with high reliability and long term stability
- Smart Trend™ indicators identify rising, falling or stable readings
- Certificate of Calibration showing traceability to NIST included
- Conforms to national and international standards including ISO and ASTM

### Versatile

- Internal Memory stores datasets with the simple touch of a button
- Auto Log Mode automatically records 5 parameters at user selected time intervals. Ideal for unattended operation.
- Every stored reading is date and time stamped
- Field calibratable
- Celsius/Fahrenheit switchable
- Selectable display languages
- Hi Contrast backlit display for bright or dark environments
- Flip display enables right-side-up viewing
- Uses alkaline or rechargeable batteries (built-in charger)

### Powerful

- Universal body accepts all PosiTector DPM, 6000, and SPG probes
- Hold function freezes the display allowing readings to be manually recorded
- USB port for fast, simple connection to a PC and to supply continuous power. USB cable included
- USB mass storage – stored readings and graphs can be accessed using universal PC/Mac web browsers or file explorers. No software required
- Software updates via web keep your instrument current
- Connects to PosiTector.net (see far right panel)

D A T A S E T	
MEASURES	CALCULATES
RH – relative humidity	T <sub>d</sub> – dew point temperature
T <sub>a</sub> – air temperature	T <sub>s</sub> –T <sub>d</sub> – the difference between surface and dew point temperatures
T <sub>s</sub> – surface temperature	

## Gage Selection...

### Select Standard or Advanced Features

#### Standard Models

*Includes ALL features as shown on left plus...*

- Monochrome display
- Storage of 2,500 datasets (RH, Ta, Ts, Td, Ts–Td). Stored readings can be viewed or downloaded
- Auto Log Mode automatically records all 5 parameters at user selected time intervals. Runs unattended on batteries for up to 50 hours or continuously via USB

#### Advanced Models

*Includes ALL features as shown on left plus...*

- Hi Contrast reversible color LCD
- Storage of 20,000 datasets (RH, Ta, Ts, Td, Ts–Td) in up to 1,000 batches and sub-batches. Stored readings can be viewed or downloaded
- **NEW!** WiFi technology wirelessly synchronizes with PosiTector.net, downloads software updates, and connects to mobile devices for expanded functionality
- Auto Log Mode automatically records all 5 parameters at user selected time intervals. Data can be streamed via USB or WiFi at each interval. Runs unattended on batteries for up to 8 months or continuously via USB
- On screen help, real time graphing, picture prompting, and batch notes
- Data transfer via USB to a PC or via  Bluetooth Wireless Technology to a PC or printer
- User defined limits for all parameters with visible and audible warnings
- Wet Bulb temperature can be displayed
- Trend Charts graph readings in real-time

*Advanced model display shown in Memory Mode with real-time graphing*

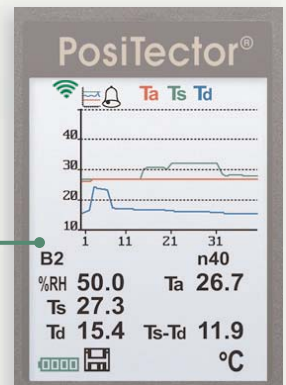

### Select from 2 Probe Styles

#### Built-in Probe

- Includes built-in surface temperature sensor

#### Separate Probe

- Includes magnetic surface temperature sensor with armored cable. Ideal for unattended auto logging during work shift or at night
- Includes magnetic mount for rubber holster to attach the instrument onto steel structures
- Accepts other optional K-type sensors

## Tough Features...

Sealed USB Port for communicating with a PC or Mac

Water and dust resistant – weatherproof

Hi resolution color LCD

Scratch/solvent/impact resistant lens

Advanced model shown in Memory and Alarm Modes

Universal body accepts all PosiTector DPM, 6000 and SPG probes

Solvent, acid, oil resistant, hi-grade, industrial strength housing

Multi-function navigation button

Shock-absorbing, protective rubber holster with belt clip and wrist strap

Air temperature and humidity sensor

White sensor housing reduces the effect of direct sunlight

Built-in thermocouple surface temperature sensor



### Example of Advanced model with Auto Log Display

Batch Number

Number of stored datasets

All 5 parameters are constantly updated and displayed simultaneously

Smart Trend™ Indicators identify rising, falling or stable readings

Countdown timer

## PosiTector.net by DeFelsko

Home

My Gages

What's New

My Account

where your gage meets the cloud™

PosiTector.net



WiFi



**A free web-based application offering secure centralized management of measurement data**

- Synchronize measurement data when connected via USB or WiFi (Advanced models only)—readings are uploaded to a secure server; images and batch notes are downloaded to your instrument
- Manipulate uploaded data using a standard internet web browser from any location in the world—jobsite or head office
- Generate reports and graphs with annotations and user selected images
- Share measurement data with authorized users via a secure login from any computer and most web enabled devices
- Export data to XML and text files
- Visit [www.defelsko.com/PosiTectorNET](http://www.defelsko.com/PosiTectorNET) for a demonstration

Flip Display enables right-side-up viewing in any position



Standard models shown

# Universal body accepts all PosiTector® DPM, 6000 and SPG probes



Analyze uploaded readings using a web browser from anywhere – jobsite or head office.

## Additional K-type Sensors for use with separate probe

- **Hand-held Surface Temperature Sensor** – for spot checking hard-to-reach surfaces
- **Self-adhering Surface Temperature Sensor** – sticks to solid materials including aluminum, wood, concrete, etc. Ideal for unattended monitoring
- **Liquid Temperature Sensor** – general purpose sensor with stainless steel shaft

## Accessories

**Bluetooth™ Printer** receives data from Advanced models

**Rechargeable Batteries** – a set of eneloop NIMH AAA batteries

**AC Power Kit** for continuous operation or battery charging –works in any country

**Protective Lens Shields** protect the display from overspray



Probe Style	Built-in	Separate	Specifications	Range	Accuracy	Resolution
<b>Ordering Guide</b>			<b>Surface Temperature</b>	-40° to 80° C	± 0.5° C	0.1° C
				80° to 190° C	± 1.5° C	
				-40° to 175° F	± 1° F	0.1° F
				175° to 375° F	± 3° F	
<b>Standard</b>	DPM1	DPMS1	<b>Air Temperature</b>	-40° to 80° C	± 0.5° C	0.1° C
				-40° to 175° F	± 1° F	0.1° F
<b>Advanced</b>	DPM3	DPMS3	<b>Humidity</b>	0 to 100%	± 3%	0.1%

**All Instruments Come Complete** with humidity, air and surface temperature sensors, protective rubber holster with belt clip, wrist strap, 3 AAA alkaline batteries, instructions, nylon carrying case with shoulder strap (Built-in probe models), hard shell carrying case (Separate probe models), protective lens shield, Long Form Certificate of Calibration traceable to NIST, USB cable, two (2) year warranty.

**Size:** 159 x 61 x 31 mm (6.25 x 2.4 x 1.2 in.)

**Weight:** 150 g (5.3 oz.) without batteries

Conforms to ISO 8502-4, BS 7079-B4, ASTM D3276 and US Navy NSI 009-32, IMO PSPC, SSPC-PA7 and others





# PosiTector® **UTG**

*Ultrasonic Thickness Gage*

Measures the wall thickness of materials such as steel, plastic and more



**UTG M Thru-Paint models** measure the metal thickness of a painted structure without having to remove the coating.

*UTG C3 Advanced model shown with Corrosion Probe*



**DeFelsko®**  
The Measure of Quality



Available on the  
**App Store**

# PosiTector® Ultrasonic Thickness Gages

## All Gages Feature...

### Simple

- Enhanced one-handed menu navigation
- Pre-programmed velocities—simply select from a list of common materials or enter your own with ease
- **SmartCouple™** mode eliminates unintentional decoupling—ensures continuous measurements while measuring on scaled or pitted surfaces—ideal for analyzing large areas using multiple passes
- Flashing display—ideal in a noisy environment
- RESET feature instantly restores factory settings

### Durable

- Solvent, acid, oil, water and dust resistant—weatherproof
- Impact resistant lens
- Shock-absorbing, protective rubber holster with belt clip
- Two year warranty on body AND probe

### Accurate

- Precision transducers provide fast, accurate readings
- Certificate of Calibration showing traceability to NIST included
- Conforms to national and international standards including ASTM E797
- Built-in temperature compensation ensures measurement accuracy

### Versatile

- Universal Gage Body accepts all PosiTector UTG, 6000, DPM and SPG probes
- Flip display enables right-side-up viewing
- Selectable display languages
- Hi contrast backlit display for bright or dark environments
- Single or two point adjustment
- Inch/mm switchable
- Uses alkaline or rechargeable batteries (built-in charger)

### Powerful

- Min Scan mode—measurement rate of up to 20 readings per second with onscreen min/max for quick inspection over a large area
- Continually displays/updates average, standard deviation, min/max thickness and number of readings while measuring
- HiLo alarm audibly and visibly alerts when measurements exceed user-specified limits
- Screen Capture—record and save screen images into USB flash memory for record keeping and review
- USB port for fast, simple connection to a PC and to supply continuous power. USB cable included
- Every stored measurement is date and time stamped
- Software updates via web keep your gage current
- Connects to PosiTector.net (see next page)

**USB mass storage—**stored readings and graphs can be accessed using universal PC/Mac web browsers or file explorers. No software required



## Gage Selection

### Select Standard or Advanced Features

#### Standard Models

**Includes ALL features as shown on left plus...**

- Monochrome display with transfective technology enhances sunlight readability
- Storage of 250 readings—stored readings can be viewed or downloaded

#### Advanced Models

**Includes ALL features as shown on left plus...**

- Hi contrast reversible color LCD
- Storage of 100,000 readings in up to 1,000 batches and sub-batches
- Store thickness, profile and environmental measurements in individual batches
- Onscreen help, real time graphing, picture prompting, and more...
- Onscreen batch annotation—add notes and change batch names with the built-in keyboard
- **NEW!** WiFi technology wirelessly synchronizes with PosiTector.net, downloads software updates, and connects to mobile devices for expanded functionality
- Data transfer via USB to a PC or via Bluetooth® Wireless Technology
- A-Scan with adjustable Gain and screen capture
- B-Scan—displays a cross sectional profile of the test material



UTG C1 Standard model

### Select from 2 Probe Styles

#### UTG C – Corrosion Probe

Measures the wall thickness of materials such as steel, plastic and more. Ideal for measuring the effects of corrosion or erosion on tanks, pipes, or any structure where access is limited to one side

- 5 MHz dual element transducer with durable PEEK probe tip
- Automatic V-Path compensation for thin materials



Stainless steel probes with knurled finger grip

#### UTG M – Multiple-Echo Probe

Features Thru-Paint capability to quickly and accurately measure the metal thickness of a painted structure without having to remove the coating. The most accurate method to measure the remaining wall thickness of a painted structure because it automatically disregards the coating, lowering inspection time and expense. Also ideal for measuring on sandblasted materials or other applications requiring a durable wear face.

- 5 MHz contact probe with wear resistant Alumina probe tip
- **Multiple Echo** technique averages 3 or more echoes for accurate and reliable readings
- Toggle easily between
  - Multiple Echo** mode to eliminate coating thickness and...
  - Single Echo** mode to detect pits and flaws, and to increase the measurement range





## Tough **NEW** Features

Sealed USB port for communicating with a PC or Mac

Water and dust resistant—weatherproof

Hi Resolution Color LCD

Advanced model shown in B-Scan

Scratch, solvent, and impact resistant lens

Solvent, acid, oil resistant, hi-grade, industrial housing

Multi-function navigation button

Shock-absorbing, protective rubber holster

Zero Plate

Quality high-flex cable and strain relief

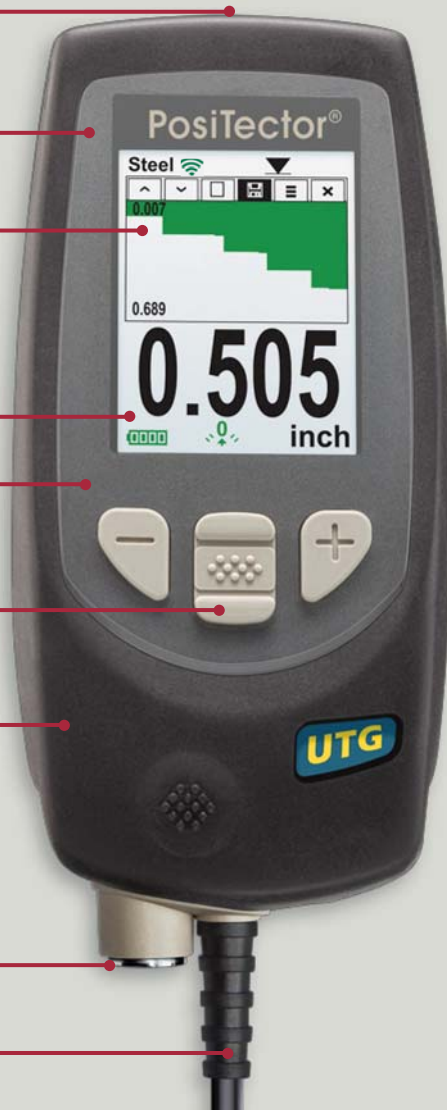

UTG M Multiple Echo Thru-Paint probe measures the thickness of a painted structure without having to remove the coating.

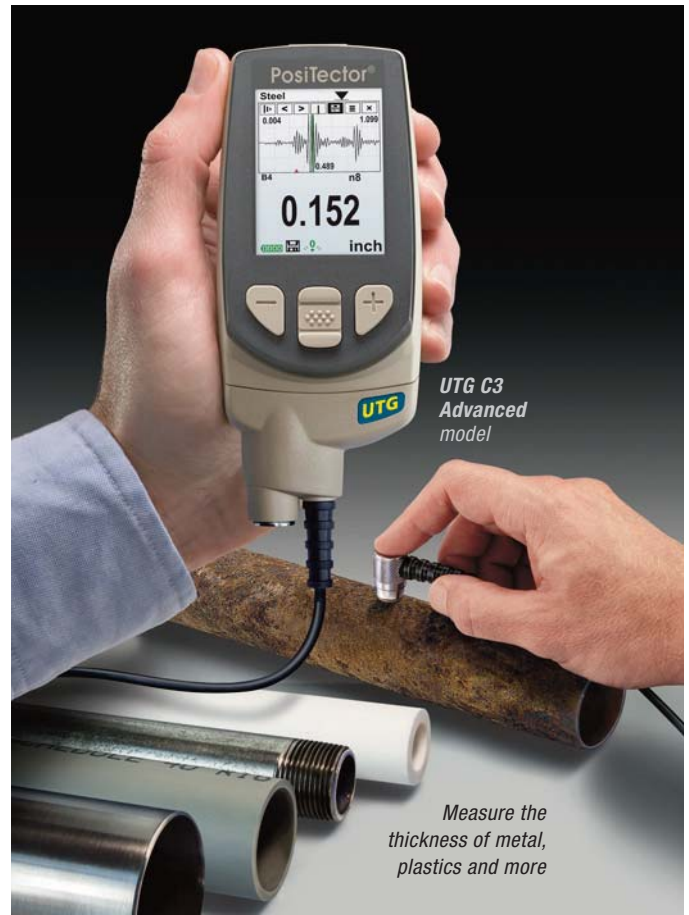

UTG C3 Advanced model

Measure the thickness of metal, plastics and more

**PosiTector.net** by DeFelsko

Home My Gages What's New My Account

where your gage meets the cloud™

PosiTector.net

Included web-based application offers secure centralized management of measurement data

- Synchronize measurement data when connected via USB or WiFi (Advanced models only)— readings are uploaded to a secure server; images and batch notes are downloaded to your instrument
- Manipulate uploaded data using a standard internet web browser from any location in the world — jobsite or head office
- Generate reports and graphs with annotation and user selected images
- Share measurement data with authorized users via a secure login from any computer and most web enabled devices
- Export data to XML and text files
- Visit [www.defelsko.com/PosiTectorNET](http://www.defelsko.com/PosiTectorNET) for a demonstration



Visit [www.defelsko.com/applications.htm](http://www.defelsko.com/applications.htm) to view **Inspection Application Notes**

PosiTector <sup>UTG</sup> ORDERING GUIDE			
Probe Style	UTG C Corrosion Probe	UTG M Multiple Echo Probe	
Standard Model	UTG C1	UTG M1	
Advanced Model	UTG C3	UTG M3	
Probe Type	5 MHz Dual Element	5 MHz Contact	
Mode	Single Echo	Single Echo	Multiple Echo
Measurement Range*	0.040" to 5.000" 1.00 to 125.00 mm	0.100" to 5.000" 2.50 to 125.00 mm	0.100" to 2.500" 2.50 to 60.00 mm
Thru-Paint Capability	no	no	yes
Measurement Rate – Normal	6 readings/sec	4 readings/sec	
Measurement Rate – Scan	20 readings/sec	4 readings/sec	
Resolution	0.001" 0.01 mm	0.001" 0.01 mm	
Accuracy	±0.001" ±0.03 mm	±0.001" ±0.03 mm	

\* Measurement range is for carbon steel and depends upon surface condition, temperature and material.

### Accessories

- **Calibration Test Block** to fulfill both ISO and in-house quality control requirements
- **Bluetooth™ Printer** receives data from Advanced models

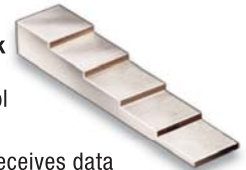

- **Rechargeable Batteries**—a set of eneloop NiMH AAA batteries
- **AC Power Kit** for continuous operation or battery charging—works in any country
- **Protective Lens Shields** protect the display from overspray and debris

### Universal Gage Body

- Universal Gage Body accepts all PosiTector **UTG, 6000, SPG** and **DPM** probes



### Probe Details

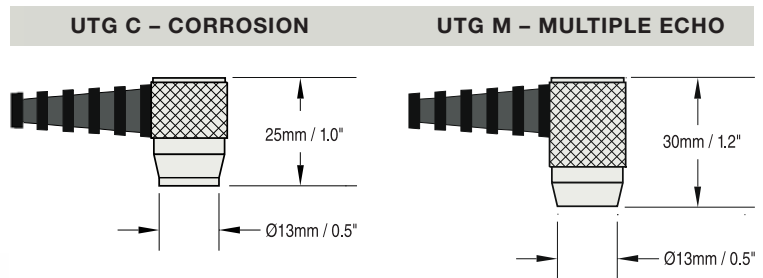

**ALL GAGES COME COMPLETE** with body and probe, couplant, protective rubber holster, belt clip, wrist strap, 3 AAA alkaline batteries, instructions, nylon carrying case with shoulder strap, protective lens shield, Long Form Certificate of Calibration traceable to NIST, USB cable, PosiTector.net account, two (2) year warranty.

**SIZE:** 146 x 61 x 28 mm (5.75" x 2.4" x 1.1")

**WEIGHT:** 140 g (4.9 oz.) without batteries  
Conforms to ASTM E797



China Marketing:

TEL: 86 010 82951585 82946733 4000240008

Http://www.1718-show.cn





# PosiTector<sup>®</sup> *SPG*

## Surface Profile Gage



Measures and records  
peak to valley  
surface profile height



**WEATHERPROOF**



**DeFelsko<sup>®</sup>**  
The Measure of Quality



Available on the  
App Store





# PosiTector® *Surface Profile Gage*

## All Gages Feature...

### Simple

- Fast measurement rate of over 50 readings per minute – ideal for quickly and accurately measuring large surface areas
- Enhanced one-handed menu navigation
- RESET feature instantly restores factory settings

### Durable

- Solvent, acid, oil, water and dust resistant – weatherproof
- 60° angle tungsten carbide tip for long life and continuous accuracy – field replaceable
- Rugged, outdoor/indoor instrument – ideal for field or shop use
- Shock-absorbing, protective rubber holster with belt clip
- Two year warranty on body and probe

### Accurate

- Built-in temperature compensation ensures measurement accuracy
- Certificate of Calibration showing traceability to NIST included
- Glass zero plate and metal shim included
- Conforms to national and international standards including ISO and ASTM

### Versatile

- Universal gage body accepts ALL PosiTector SPG, DPM and 6000 probes
- 30° angle interchangeable probe tip available for special applications
- Selectable display languages
- Hi Contrast backlit display for bright or dark environments
- Flip display enables right-side-up viewing
- Uses alkaline or rechargeable batteries (built-in charger)

### Powerful

- Continually displays/updates average, standard deviation, min/max thickness and number of readings
- HiLo alarm audibly and visibly alerts when measurements exceed user-specified limits
- Every stored measurement is date and time stamped
- USB port for fast, simple connection to a PC and to supply continuous power. USB cable included
- USB mass storage – stored readings and graphs can be accessed using universal PC/Mac web browsers or file explorers. No software required
- Software updates via web keep your gage current
- Connects to PosiTector.net

PosiTector <i>SPG</i> Ordering Guide	
Standard	SPG1
Advanced	SPG3
Range	0 – 500 µm (0 – 20 mils)
Accuracy	± (5 µm + 5%) ± (0.2 mil + 5%)

## Select Standard or Advanced Features

### Standard Model

**Includes ALL features as shown on left plus...**

- Monochrome display
- Storage of 250 readings—stored readings can be viewed or downloaded

### Advanced Model

**Includes ALL features as shown on left plus...**

- Hi Contrast reversible color LCD
- Storage of 100,000 readings in up to 1,000 batches and sub-batches
- SmartBatch™ allows entry of user-defined parameters and criteria to comply with various standards and test methods
- On screen help, real time graphing, picture prompting and batch notes
- **NEW!** WiFi technology wirelessly synchronizes with PosiTector.net, downloads software updates, and connects to mobile devices for expanded functionality
- Data transfer via USB to a PC or via Bluetooth® Wireless Technology to a PC or printer

*Advanced Model display shown in Memory mode with real-time graphing*



## Accessories

- Replacement Tungsten Carbide Probe Tips – 2 angles available 60° or 30°, includes replacement tool
- Bluetooth® Printer receives data from Advanced Models
- AC Power Kit for continuous operation or battery charging – works in any country
- Rechargeable Batteries – a set of eneloop NiMH AAA batteries
- Protective Lens Shields protect the display from overspray

**All Gages Come Complete** with glass zero plate, metal shim, protective rubber holster with belt clip, wrist strap, 3 AAA alkaline batteries, instructions, nylon carrying case with shoulder strap, protective lens shield, Long Form Certificate of Calibration traceable to NIST, USB cable, two (2) year warranty.



### Size:

137 x 61 x 28 mm  
(5.4" x 2.4" x 1.1")

**Weight:** 140 g (4.9 oz.)  
without batteries

Conforms to ASTM D4417-B, AS 3894.5-C (with optional 30° tip angle), U.S. Navy NSI 009-32, SANS 5772 and others



# PosiTector Inspection Kits

## Each Inspection Kit contains:

- PosiTector Gage Body – Standard or Advanced
- PosiTector **6000** Coating Thickness Probe – select from a variety of measurement ranges and probe styles
- PosiTector **DPM** Environmental Probe
- PosiTector **SPG** Surface Profile Probe

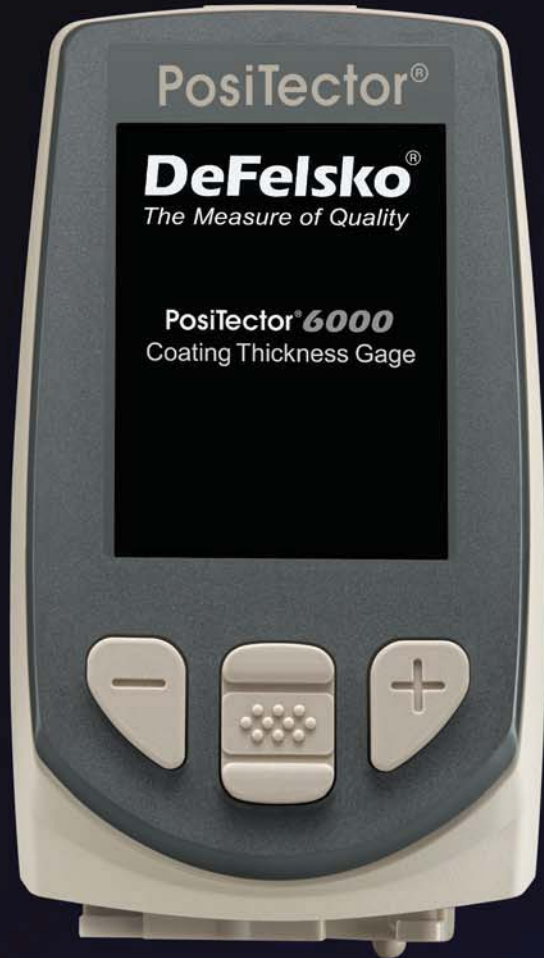

KITF3 Shown



**DeFelsko®**  
*The Measure of Quality*

PosiTector body accepts all PosiTector **6000**, **DPM**, and **SPG** probes easily converting from a coating thickness gage to a dew point meter or surface profile gage.

### Select Standard or Advanced Features

for a complete comparison visit [www.defelsko.com/kits/kit\\_features.htm](http://www.defelsko.com/kits/kit_features.htm)

### Standard--- Model Inspection Kits

Each Standard Kit contains the **PosiTector Standard** gage body and 3 interchangeable probes – coating thickness, environmental and surface profile.

#### Features include

- Monochrome display
- Gage stores readings for one probe at a time

#### Coating Thickness with Standard models

- Storage of 250 readings – stored readings can be viewed or downloaded

#### Environmental Monitoring with Standard models

- Storage of 2,500 datasets (RH, Ta, Ts, Td, Ts-Td). Stored readings can be viewed or downloaded.
- Auto Log Mode automatically records all 5 parameters at user selected time intervals. Runs unattended on batteries for up to 50 hours or continuously via USB

#### Surface Profile with Standard Models

- Storage of 250 readings – stored readings can be viewed or downloaded

### Advanced Model Inspection Kits

Each Advanced Kit contains the **PosiTector Advanced** gage body and 3 interchangeable probes – coating thickness, environmental and surface profile.

#### Features include

- Hi Contrast reversible color LCD
- Storage of 100,000 readings in up to 1,000 batches and sub-batches. Easily store thickness, climatic conditions and profile height in multiple batches.
- Onscreen batch annotation - add notes, change batch names and more with built-in QWERTY keyboard
- Onscreen help, real time graphing, picture prompting and batch notes
- **NEW!** WiFi technology wirelessly synchronizes with PosiTector.net, downloads software updates, and connects to mobile devices for expanded functionality
- Data transfer via USB to a PC or via Bluetooth Wireless Technology to a PC or printer

#### Coating Thickness with Advanced models

- Multiple stored calibration adjustments for measuring on a variety of substrate conditions
- SSPC PA2 feature determines if film thickness over a large area conforms to user-specified min/max levels
- PSPC 90/10 feature determines if a coating system complies with an IMO performance standard for protective coatings

#### Environmental Monitoring with Advanced models

- Storage of 20,000 datasets (RH, Ta, Ts, Td, Ts-Td) in up to 1,000 batches and sub-batches. Stored readings can be viewed or downloaded.
- Auto Log Mode automatically records all 5 parameters at user selected time intervals. Data can be streamed via USB or Bluetooth at each interval. Runs unattended on batteries for up to 8 months or continuously via USB
- User defined limits for all parameters with visible and audible warnings
- Wet bulb temperature can be displayed
- Trend charts graph readings in real-time

#### Surface Profile with Advanced models

- SmartBatch™ allows entry of user-defined parameters and criteria to comply with various standards and test methods

### Each Inspection kit contains:

- PosiTector Gage Body – Standard or Advanced
- PosiTector **6000** Coating Thickness Probe –select from a variety of measurement ranges and probe styles
- PosiTector **DPM** Environmental Probe
- PosiTector **SPG** Surface Profile Probe



KITF3 Shown

### Ordering Guide

Inspection Kit	PosiTector Body	Coating Thickness Probe
KITF1	Standard	6000-F
KITFS1		6000-FS
KITFN1		6000-FN
KITFNS1		6000-FNS
KITF3	Advanced	6000-F
KITFS3		6000-FS
KITFN3		6000-FN
KITFNS3		6000-FNS

**Kits come complete** with a gage body (Standard or Advanced), coating thickness probe(user selected), environmental probe, surface profile probe, precision plastic shims, glass zero plate and metal shim, protective rubber holster with belt clip, wrist strap, 3 AAA alkaline batteries, 3 instruction manuals, hard shell case, protective lens shield, 3 Long Form Certificates of Calibration traceable to NIST, USB cable and 2 year warranty on gage body and probes.

**Case Size:** 30 cm (l) x 25 cm (w) x 10 cm (d)  
12" (l) x 10" (w) x 4" (d)

**Weight:** 1.3 kg (2.8 lbs.)

**DeFelsko**®

China Marketing:

TEL:86 010 82951585 82946733 4000240008

[Http://www.1718-show.cn](http://www.1718-show.cn)





# DeFelsko Coating Thickness Standards

Certified coating thickness standards are ideal for verifying the accuracy and operation of coating thickness gages and are an important component in fulfilling both ISO and in-house quality control requirements.

Many organizations require verification of gage accuracy at the test site each time a coating thickness gage is put into service and at frequent intervals during use. Ideal for this purpose, DeFelsko certified coating thickness standards have measured values traceable to a National Metrology Institution.

## Certified Coated Metal Plates and Polystyrene Blocks

- Used to verify the accuracy and operation of any Type 1 (mechanical) and Type 2 (electronic) magnetic, eddy-current or ultrasonic coating thickness gage
- Ideal for use in the calibration lab, in the field or on the factory floor
- Standards with steel or aluminum substrates consist of 4 plates mounted in a protective binder
- Polystyrene thickness standards consist of 4 blocks supplied in a rugged acrylic storage box
- Individually serialized for traceability to NIST or PTB - includes a Certificate of Calibration
- Certified and labeled in both Metric and Imperial units



S1 Ferrous



A1 Non-Ferrous



Individual plates are available

P1 Polystyrene



**Plate Diameter:** 38 mm (1.5")  
**Measurement Diameter:** 25 mm (1")

**Polystyrene Blocks:** 38 x 70 mm (1.5" x 2.75")

Order Code	Ideal for	Approximate Thickness				Coating/Substrate	Accuracy
		Plate 1	Plate 2	Plate 3	Plate 4		
S1	PosiTector 6000 F, FS, FRS, FN, FNS, FNRS PosiTest F & FM	0	75 µm 3 mils	250 µm 10 mils	1500 µm 60 mils	Epoxy on Steel (Ferrous)	+/- 0.43 µm +/- 0.017 mil
S2	PosiTector 6000 F0S, F45S, F90S PosiTest DFT Ferrous & Combo	0	75 µm 3 mils	250 µm 10 mils	1000 µm 40 mils		
S3	PosiTest G & GM PosiPen A, B & C	0	15 µm 0.6 mils	40 µm 1.6 mils	100 µm 4 mils		
A1	PosiTector 6000 N, NS, NRS, FN, FNS, FNRS	0	75 µm 3 mils	250 µm 10 mils	1500 µm 60 mils	Epoxy on Aluminum (Non-Ferrous)	+/- 0.43 µm +/- 0.017 mil
A2	PosiTector 6000 NAS, N0S, N45S, N90S PosiTest DFT Combo	0	75 µm 3 mils	250 µm 10 mils	500 µm 20 mils		
A3	PosiTector 100B, 200, 200B	75 µm 3 mils	125 µm 5 mils	250 µm 10 mils	500 µm 20 mils		
P1	PosiTector 6000 FT, FTS, NTS, FNFS	375 µm 15 mils	2 mm 80 mils	4.5 mm 185 mils	6.5 mm 250 mils	Polystyrene Blocks	+/- (2.5 µm + 0.05% of thickness) +/- (0.1 mil + 0.05% of thickness)
P2	PosiTector 6000 FHS, NHS, EOC	2.5 mm 100 mils	6.5 mm 250 mils	13 mm 500 mils	19 mm 750 mils		
P3	PosiTector 100C	375 µm 15 mils	1.5 mm 60 mils	2.5 mm 100 mils	4.5 mm 185 mils		
P4	PosiTector 100D	1.5 mm 60 mils	2.5 mm 100 mils	4.5 mm 185 mils	6.5 mm 250 mils		
P5	PosiTector 6000 FKS, NKS	1.5 mm 60 mils	2.5 mm 100 mils	6.5 mm 250 mils	12 mm 480 mils		
P6	PosiTector 200C	375 µm 15 mils	1.5 mm 60 mils	2.5 mm 100 mils	3 mm 125 mils		

Select the Standard that most closely matches the measuring range of your gage.  
 All certified standards are supplied with a Certificate of Calibration traceable to NIST or PTB.



# DeFelsko Plastic Shims

- Simulate a coating over a particular substrate material or shape. Gage performance can be conveniently verified on a regular basis as required by some international test methods
- For use with all Type 2, electronic coating thickness gages
- Protects the probe from damage or premature wear when placed over hot or abrasive surfaces
- Can be placed on top of soft or tacky coating films to obtain thickness measurements without the gage probe depressing the coating film

## Certified Plastic Shims

- Certified shims provide an economical alternative to Coated Metal Plates but have a reduced accuracy
- Each shim is packaged in its own protective plastic pouch
- Certificate of Calibration showing traceability to NIST is included with each shim or set of shims
- Certified and labeled in both Metric and Imperial units



Certified Plastic Shims

## Non-Certified Plastic Shims

- Provide a quick operational check of the instrument by allowing the user to perform practice measurements
- Can be used to protect the probe when measuring on tacky, rough or hot surfaces
- Labeled in both Metric and Imperial units
- Available as a set of 5 (below)

Approximate Thickness	Color	Accuracy
25 $\mu\text{m}$ (1 mil)	Orange	+/- 20%
50 $\mu\text{m}$ (2 mils)	Red	+/- 10%
125 $\mu\text{m}$ (5 mils)	Blue	+/- 5%
250 $\mu\text{m}$ (10 mils)	Brown	+/- 5%
500 $\mu\text{m}$ (20 mils)	Yellow	+/- 5%



Steel and aluminum zero plates are available

Order Code	Approximate Thickness	Color	Accuracy
CS1	25 $\mu\text{m}$ (1 mil)	Orange	+/- 2 $\mu\text{m}$ (+/- 0.08 mils)
CS2	50 $\mu\text{m}$ (2 mils)	Red	
CS3	75 $\mu\text{m}$ (3 mils)	Green	
CS5	125 $\mu\text{m}$ (5 mils)	Blue	
CS10	250 $\mu\text{m}$ (10 mils)	Brown	
CS20	500 $\mu\text{m}$ (20 mils)	Yellow	
CS40	1000 $\mu\text{m}$ (40 mils)	White	
CS60	1500 $\mu\text{m}$ (60 mils)	Black	
CSS	Complete set of 8		



Non-Certified Plastic Shims

A package of 5 non-certified shims is included with all DeFelsko electronic coating thickness gages (Type 2).

Note: Shims are generally not acceptable for use with Type 1, magnetic pull-off gages such as the PosiTest FM/GM and PosiPen.



**DeFelsko Corporation**, a U.S. manufacturer of coating thickness gages and inspection instruments, has been providing **Simple, Durable and Accurate** gages since 1966.

Our state-of-the-art facility in Ogdensburg, New York houses research, manufacturing, sales, service, and shipping departments. Every gage is inspected under our strict quality guidelines.

In addition to high product quality we are proud to offer the **DeFelsko Advantage:**

## Technical Support

Our highly trained technical support team is dedicated to solving problems quickly. Call or email our technical department for all questions including order status, sales, technical, quality & calibration, accounting, shipping or general information.

## Fast Service

Our service department's goal is to evaluate your gage and contact you within one (1) day of our receiving the gage in for service or calibration.

## On-Site Manufacturing

All parts are available on-site which gives us the ability to repair gages quickly and ship most gages within one day anywhere in the world.



## DeFelsko® Contact Information

China Marketing:

TEL:86 010 82951585 82946733 4000240008

[Http://www.1718-show.cn](http://www.1718-show.cn)

**DeFelsko Corporation**

802 Proctor Avenue

Ogdensburg, New York 13669 USA



© DeFelsko Corporation USA 2012. Technical Data subject to change without notice. v:DCat.w/w0812

